



## Yuasa Technical Data Sheet

### Yuasa M26-80S - Marine Batteries

#### Performance

Voltage	12V
Capacity (20-hour)	80Ah
Cold Cranking Amps (EN1)	600A
Marine Cranking Amps (MCA)	720A
Watt Hour	960Wh

#### Dimensions

Length	260mm
Width	174mm
Height	225mm



#### Weights & Measures

Mean Weight with Acid	18.9kg
-----------------------	--------

#### Container Features

Case Type	GR24 BCI
Cell Layout	1
Hold Down	B5
State of Charge Indicator	✓
Handles	✓
End Venting	✓
Semi-Traction Features	✓
Lid Type	SMF Double Lid

#### Technology

Flame Arrestor	✓
Technology	Ca/Ca
Separator	PE
Recommended Charge Rate	4A

#### Terminal Type

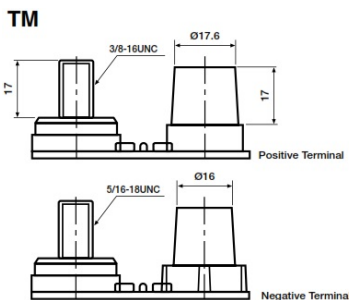

#### Cell Assembly Layout

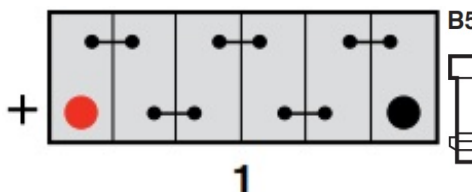

#### Battery Hold-down

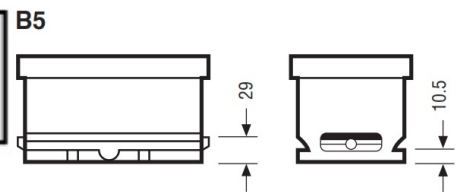

Data Sheet generated on 16/08/2023 - E&OE