



Yuasa Technical Data Sheet

Yuasa M27-EFB - Marine Batteries

Performance

Voltage	12V
Capacity (20-hour)	90Ah
Cold Cranking Amps (EN1)	700A
Marine Cranking Amps (MCA)	840A
Watt Hour	1080Wh

Dimensions

Length	304mm
Width	173mm
Height	225mm



Weights & Measures

Mean Weight with Acid	22.3kg
-----------------------	--------

Container Features

Case Type	GR27 BCI
Cell Layout	1
Hold Down	B1
State of Charge Indicator	✓
Handles	✓
End Venting	✓
Semi-Traction Features	✓
Lid Type	SMF Double Lid

Technology

Flame Arrestor	✓
Technology	Ca/Ca
Separator	PE
Recommended Charge Rate	6A

Terminal Type

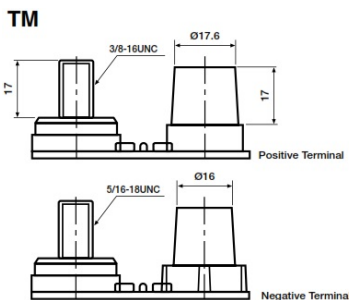

Cell Assembly Layout

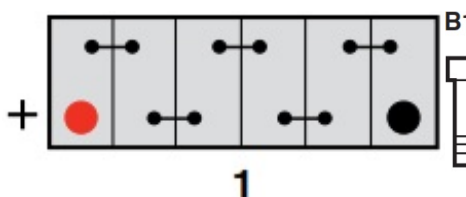

Battery Hold-down

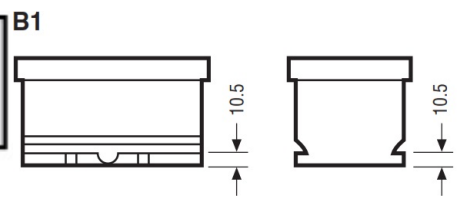

Data Sheet generated on 16/08/2023 - E&OE